



PERFORMANCE
SPORTS SYSTEMS

VOLLEYBALL

NASC WE ARE LIVE



ARCHITECTURAL
EQUIPMENT
PRODUCT CATALOG



WHAT FACILITY USERS ARE SAYING:

"Gared Performance Sports Systems has been a great partner to Westfield Athletics. We have purchased many products from them, and the quality and durability have been excellent. We strive to have first class facilities for our athletes and community, and they help us accomplish our goals. When needed, the service has been timely and outstanding as well. We highly recommend Gared Performance Sports Systems to any school or business that wants top quality products and service they can count on."

Andrew Tebbe
Athletic Director
Westfield High School
Westfield, Indiana



Project sold and installed by our local partner.

Why PERFORMANCE SPORTS SYSTEMS

TRADITION OF EXCELLENCE

- Over 100 years' experience manufacturing indoor and outdoor institutional sports equipment.
- Proven industry leader, providing consistent quality with a focus on safety.
- Full understanding of the sports facility industry and various markets.

INDUSTRY INNOVATION

- First to develop and provide a "no-tie" basketball goal net attachment.
- First to develop and provide a rear mount breakaway goal.
- First to develop and provide a 42" glass backboard.
- First to develop and provide a top roll gym divider curtain.
- First to develop a safety catch system "safstop" to protect players in event of cable failure.
- Industry innovator designing portable basketball systems with hydraulic, spring, and now hybrid systems.
- First to develop and provide a mast safety clamp incorporating anti-slip and anti-spin features.

TESTED AND CERTIFIED PRODUCTS

- Products tested and approved by FIBA.
- Structures are seismic tested to meet California DSA requirements.
- Wall pads tested for impact and fire/smoke safety.
- Products meet NBA, NCAA, and NFHS requirements for competition play.

EXPERIENCED DESIGN/ENGINEERING TEAM

- Full in-house engineering team devoted to engineering safe and quality products.
- Advanced software tools - CAD, Inventor, 3D renderings, and BIM/REVIT modeling.
- Load calculations provided with every project submittal.
- Custom design solutions for unique customer needs.

FULL SERVICE MANUFACTURER

- Complete control of design, engineering, and manufacturing processes.
- Provide design services
- Full project management services partnered with local distributors.

EXCEPTIONAL CUSTOMER CARE

- Helpful, reliable, and friendly customer care team.
- Trained with extensive full line product knowledge.
- Experience with troubleshooting for any customer issues.

LOCAL DISTRIBUTION PARTNERS

- Personalized onsite service and support.
- Design consultation.
- Trained and certified installers.
- Trained on maintenance and service of our equipment.
- Product training available for customers.
- Local partners can assist customers in any situation.

TABLE OF CONTENTS

CEILING-HUNG AND WALL-MOUNTED BASKETBALL BACKSTOPS	4 - 6
BACKBOARDS, RIMS & PADDING	7 - 9
GYMNASIUM ACCESSORIES	10 - 11
MAT CARRIER SYSTEMS AND INDOOR SPORT CAGES	12 - 13
DIVIDER CURTAINS	14 - 16
TOTAL SYSTEM CONTROL	17
WALL PADS	18 - 19
CEILING-HUNG FOOTBALL & P.E. EQUIPMENT	20
PORTABLE BASKETBALL SYSTEMS	21
VOLLEYBALL SYSTEMS AND ACCESSORIES	22 - 25
OUTDOOR BASKETBALL SYSTEMS	26 - 27
FIELD SPORTS EQUIPMENT	28 - 29
OUTDOOR VOLLEYBALL, TENNIS, & PICKLEBALL EQUIPMENT	30
BLEACHERS AND BENCHES	31





CEILING-HUNG BASKETBALL BACKSTOPS

ADJUSTABLE MAST HANGER

Engineered hangers designed for strength and safety at critical attachment points provide unequalled performance and reliability.

CHANNEL SUPPORT

4" structural steel top spreader supports our welded frame design, allowing the weight of the backstop to assist with locking of the brace.

OFFSET DESIGN

Our vertical support mast has an offset design, allowing the weight of the backstop to assist with the locking of the brace.

FULLY WELDED FRAME

All single post designs under 31' incorporate a 6-5/8" diameter vertical support mast with fully welded frame for maximum rigidity. The mast is stabilized by rectangular tube side sway braces welded to the support channel and the mast. The sways are precision cut to match up perfectly to the vertical mast and horizontal top channel.

DIRECT GOAL ATTACHMENT

All designs incorporate a direct goal mount feature to distribute all stress or load on the goal directly to the vertical support mast. This design is backed by our lifetime backboard warranty.

POWDERCOAT FINISH

All steel components have a high quality baked-on powdercoat finish. Color choices shown below; custom colors are available.

We offer many options for facility designers to meet the needs of their customers. Our high-performance equipment is designed with structural integrity and versatility for all levels of competition.

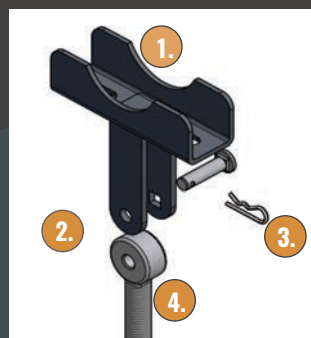

1. 50% MORE WELD THAN THE COMPETITION
2. 1" WIDE BEARING SURFACE, TWICE AS MUCH AS THE COMPETITION
3. 1/2" DIAMETER NON-ROTATING PIN
4. 7/8" DIAMETER FORGED STEEL THREADED HANGER

TESTED STRUCTURAL DESIGN STRENGTHS

FIBA CERTIFIED

All single post backstops have been tested and approved by FIBA, meeting their strict requirements for stability and safety.

SEISMIC TESTING

Our equipment and hardware design have been approved by the state of California, meeting or exceeding all seismic testing requirements.

OVERHEAD DESIGN HARDWARE

Clean overhead designs are built to accommodate many building conditions while providing the strength to support the load of the equipment and the stress caused by years of competitive use.

CEILING HUNG BACKSTOP POWDERCOAT COLORS

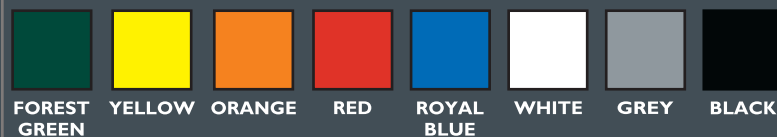

SINGLE POST CEILING STRUCTURES PRODUCT GUIDE

MODEL NUMBER	MODELS 3103/3102	MODELS 3105/3104	MODELS 3107/3106	MODELS 3109/3108	MODELS 3111/3110
STRUCTURE					
DESIGN APPLICATION	Best for facilities with adequate space behind the backboard to brace the structure and no obstructions or clearance issues in front of the structure. This design offers maximum clearance above the court.	Great choice for those facilities with clearance issues over the court that will not allow front fold design, yet offers adequate space behind the backstop to allow rear folding for storage.	Best used in facilities designed without adequate space behind the backstop structure for rear bracing, and with no clearance issues over the court for front bracing to fold forward and up for storage.	This model is the perfect solution for the fieldhouse or gymnasium with large amounts of equipment, and limited space behind the backboard and/or other conditions that don't allow front fold, but still require folding the backstop up to a stored position.	Non-folding design with ceiling brace for those projects not requiring backstops to be moved and will not allow bracing to the wall.
BRACE DIRECTION	REAR BRACED	REAR BRACED	FRONT BRACED	SIDE BRACED	FRONT OR REAR CEILING BRACED
FOLD DIRECTION	FORWARD FOLD	REAR FOLD	FORWARD FOLD	SIDE FOLD	STATIONARY
MAST TYPE	SINGLE	SINGLE	SINGLE	SINGLE	SINGLE
MAXIMUM & MINIMUM HEIGHT RESTRICTIONS BY MODEL					
31' MAX, 18' MIN	3103	3105	3107	3109	3111
32' MIN	3102	3104	3106	3108	3110
MAST CONSTRUCTION BY MODEL					
WELDED	3103	3105	3107	3109	3111
CLAMPED	3102	3104	3106	3108	3110
MODEL NUMBER	MODELS 3205/3204	MODEL 3305	MODELS 3207/3206	MODELS 3209/3208	MODELS 3115/3114
STRUCTURE					
DESIGN APPLICATION	A bent single post rear braced rear folding design which reduces the space required behind the backstop for the brace.	A compact design that utilizes a track system to move the backstop forward as it is raised up and back, great for those facilities lacking space for a standard backfold and clearance issues for a standard front fold backstop.	A bent single post front braced forward fold design which reduces the space required in front of the backboard for the brace.	A bent single post side braced side folding design which reduces the space required to the side of the backstop for the brace.	Non-folding backstop design with rear wall brace for those projects not requiring backstops to be moved. Maximum distance from wall to face of backboard is 14'.
BRACE DIRECTION	BENT REAR BRACED	REAR BRACED	BENT FRONT BRACED	BENT SIDE BRACED	WALL BRACED
FOLD DIRECTION	REAR FOLD	ROLL FOLD	FORWARD FOLD	SIDE FOLD	STATIONARY
MAST TYPE	SINGLE	SINGLE	SINGLE	SINGLE	SINGLE
MAXIMUM & MINIMUM HEIGHT RESTRICTIONS BY MODEL					
31' MAX, 18' MIN	3205	3305	3207	3209	3115
32' MIN	3204		3206	3208	3114
MAST CONSTRUCTION BY MODEL					
WELDED	3205	3305	3207	3209	3115
CLAMPED	3204		3206	3208	3114



FIBA
EQUIPMENT
& VENUE

FIBA (Fédération Internationale de Basketball) hereby declares, by means of certification, that GARED PERFORMANCE SPORTS SYSTEMS CEILING SUSPENDED MODELS 3102, 3103, 3104, 3105, 3106, 3107, 3108, 3109, 3111, 3115 fulfill the Competition Level II standards specified in the latest edition of the Equipment & Venue Approval Programme and GPSS is therefore qualified as an OFFICIAL TECHNICAL PARTNER.

WALL-MOUNTED BASKETBALL BACKSTOPS



2350

THREE-POINT WALL MOUNTS

OUR THREE-POINT WALL MOUNT SYSTEM provides the strongest wall mount structure available for facilities with budget constraints • Incorporates direct-goal attachment that transfers the load of heavy play through the backboard to the structure • 5/0 upper safety chains with heavy malleable turnbuckles provide additional support • Telescopic design allows for complete adjustability and ease of installation • Structural wood mounting pads included • Mounting hardware provided by others • Board and goal are not included unless wall mount package is purchased • Not compatible with 60" front mount or rear mount backboards • Height adjuster is optional.

2350 SERIES: THREE POINT STATIONARY WALL MOUNT

- Stationary non-folding unit
- Standard extension length available: 2' - 12'

FOUR-POINT WALL MOUNTS

FOUR-POINT WALL MOUNT SYSTEMS incorporate four point attachment for backboards with 36" x 63" or 20" x 35" mounting centers • 5/0 upper safety chains with heavy malleable turnbuckles provide additional support • Telescopic design allows for complete adjustability and ease of installation • Structural wood mounting pads included • Mounting hardware provided by others • Board and goal are not included unless wall mount package is purchased • Not compatible with 60" front mount backboards • Height adjuster is optional.

2300 SERIES: FOUR-POINT STATIONARY WALL MOUNT

- Stationary non-folding unit
- Offers the ability to mount around any obstructions.
- Offers a direct goal attachment when height adjuster is purchased.
- Standard 2' - 12' extension lengths available.
- Custom extension lengths of 13'-16' available.

2400 SERIES: FOUR-POINT FOLD UP WALL MOUNT

- Stores in fold-up vertical, compact position against wall to prevent interference with other court activities.
- In play position, unit locks into stationary 4-point position.
- Includes manual winch with crank handle; electric hoist and safstop are optional.
- Offers a direct goal attachment when height adjuster is purchased.
- Standard 4' - 12' extension lengths available.



2400

2500 SERIES: FOUR-POINT SIDE FOLD WALL MOUNT

- Stores in side fold, horizontal position against wall to allow for other court activities.
- Allow 14"-18" between wall mount in stored position and wall, depending on extension length.
- Offers a direct goal attachment when height adjuster is purchased.
- Standard 4' - 12' extension lengths available.
- Electric hoist and safstop are optional.
- Model 2500E available with electric actuator for folding unit to the wall.



2300



2500



2500E

COMPETITION GLASS BACKBOARDS

Exceeding our competitor's aluminum-framed board 650 lb pressure breaking point - our ALUMINUM-FRAMED BACKBOARDS are the strongest in the industry and resist rusting • In addition, our elite aluminum-framed boards have even stood the pressure of two decades of play in NBA arenas • STEEL-FRAMED BACKBOARDS are constructed with a heavy-gauge steel frame for superior strength during competition play • All aluminum-framed and steel-framed boards feature 1/2" tempered glass, fired-in target and border, and are available in regulation 42" x 72" or tall 48" x 72" size • All glass backboards are made in the US and meet NCAA, NAIA & NFHS specifications.

AFRG42: 42" X 72" REGULATION ALUMINUM-FRAMED GLASS BACKBOARD

AFRG48: 48" X 72" REGULATION ALUMINUM-FRAMED GLASS BACKBOARD

LXP4200: 42" X 72" REGULATION STEEL-FRAMED GLASS BACKBOARD



AFRG42

COMPETITION BREAKAWAY GOALS

OUR COLLEGIATE SERIES OF GOALS can be found in almost every facility around the world and stand up to the rigors of power players, making them our most popular line of rims • Each rim features an effective positive lock mechanism duplicating precision fly-back action dunk after dunk • The 2000+ offers easy net installation with its no-tie net attachment • The 2500 & 2500I tube-tie net attachments helps prevent hand injury • Collegiate goals have a universal backplate to seamlessly fit on any size glass backboard.

2000+: COLLEGIATE 2000 BREAKAWAY GOAL WITH NYLON NET

2500: TOURNAMENT BREAKAWAY GOAL WITH NYLON NET

2500I: INTERNATIONAL TOURNAMENT BREAKAWAY GOAL WITH NYLON NET



2000+

2000+ SPRINGS

2500



4000+

Break away from the competition with the 4000+ MDG goal • The exclusive 3-way positive lock mechanism breaks in the front and on both sides, making the MDG goal a top pick for facilities looking for a non-traditional breakaway rim • The MDG will not dangerously break upward if a player inadvertently hits it from underneath the ring • Internal torque mechanism will withstand the rigors of constant, high energy play • Tube-tie net attachment prevents hand injury and helps lengthen the life of the anti-whip net • Meets NCAA, NFHS, and NAIA rule specifications • Complies with NCAA elasticity rule • Includes GAW net and hardware.

4000+: MULTI-DIRECTIONAL BREAKAWAY GOAL WITH NYLON NET

PRO-MOLD® BOLT-ON BACKBOARD PADDING

Safeguard players from injury with our PMCE PRO-MOLD BACKBOARD PADDING • The premium pads offer an unmatched combination of softness and durability, and are flexible enough to bend without tearing, unlike competitors' products • Pads will universally fit any 72" backboard with a 2" channel • Installation is simple with the included bolt hardware and sag-resistant center rod • With an array of 14 vibrant colors, we can match any institution's school color scheme • Padding meets all FIBA, NCAA, NBA, & NFHS specifications • One pad kit protects one backboard; order a pair for a full court • Specify color when ordering.

PMCE: PRO-MOLD® BACKBOARD PADDING



FIBA
EQUIPMENT
& VENUE

FIBA (Fédération Internationale de Basketball) hereby declares, by means of certification, that WALL MOUNTED MODELS 2300-9124, 2400-9124, 2500-9124, 2500-1416 fulfill the Competition Level II and WALL MOUNTED MODELS 2300, 2400 AND 2500 fulfill the Competition Level III standards specified in the latest edition of the Equipment & Venue Approval Programme and GPSS is therefore qualified as an Official Technical Partner.

STEEL BACKBOARDS

FAN-SHAPE STEEL BACKBOARDS provide an economical board style that will withstand rugged playground use • Constructed with a 12 gauge galvanized steel shell with white powdercoat finish and optional screened target and border • Keyhole slots are positioned at 20" vertically by 35" horizontal centers for mounting • Features reinforced mounting points, including 2 safety mount holes, to reduce vibration • Available as front mount or rear mount • Rear mount steel boards are only compatible with rear mount rims • Recommended rims for front mount boards: 8550, 5500, 8800, 7550, 240, 140, 39WO • Recommended rims for rear mount boards: 6600, 266, 66T.

1245: 35" X 54" FRONT MOUNT FAN-SHAPE STEEL BACKBOARD

1245T: 35" X 54" FRONT MOUNT FAN-SHAPE STEEL BACKBOARD WITH ORANGE TARGET

1266: 35" X 54" REAR MOUNT FAN-SHAPE STEEL BACKBOARD

1266B: 35" X 54" REAR MOUNT FAN-SHAPE STEEL BACKBOARD WITH ORANGE TARGET & BORDER



1245T



1266B



1260

Durable RECTANGULAR STEEL BACKBOARDS are built strong for heavy, unsupervised play • Available in 60" and 72" board sizes • Constructed of 12 gauge steel shell with white powdercoat finish and optional orange target and border • Contains an integral reinforcing steel channel on reverse side for mounting and to provide maximum board support and stability • Features 20" x 35" mounting centers for attaching board to structure • Capable of direct mounting with integral keyhole slots to permanently attach board to post and allow goal replacement without removing board • Perforated steel models are ideal for windy locations (Not pictured - Models 1260PS and 1272PS) • Rectangular steel boards are available as front mount only • Recommended rims: 8550, 5500, 8800, 7550, 240, 39WO.

1260: 42" X 60" RECTANGULAR STEEL BACKBOARD

1260B: 42" X 60" RECTANGULAR STEEL BACKBOARD WITH ORANGE TARGET & BORDER

1272: 42" X 72" RECTANGULAR STEEL BACKBOARD

1272B: 42" X 72" RECTANGULAR STEEL BACKBOARD WITH ORANGE TARGET & BORDER



1272B

ALUMINUM BACKBOARDS

FAN-SHAPE ALUMINUM BACKBOARDS are constructed of casted aluminum for a lightweight and rust-resistant option for any indoor or playground setting • Features 20" x 35" mounting centers for attachment and two additional mounting holes to hold board in place during rim replacement • Recommended Rims: 8550, 5500, 8800, 7550, 240, 39WO • Available with brushed natural-finish aluminum, plain white, or with orange target & border.

1701: 35-1/2" X 54" FAN-SHAPE ALUMINUM BACKBOARD WITH NATURAL FINISH

1750: 35-1/2" X 54" FAN-SHAPE ALUMINUM BACKBOARD

1750B: 35-1/2" X 54" FAN-SHAPE ALUMINUM BACKBOARD WITH ORANGE TARGET & BORDER



1750B

FIBERGLASS BACKBOARDS

FIBERGLASS BACKBOARDS provide a non-glass surface with superior rebound, making them a versatile board for both indoor and outdoor play • Constructed of molded fiberglass for lightweight strength • Contains screen-printed orange target and border • Features 20" x 35" molded inserts for mounting • Available in rectangular and fan-shape sizes • All fiberglass boards carry a 10 Year Warranty when used indoors and 5 Year Warranty when used outdoors.

1301B: 39" X 54" FAN-SHAPE FIBERGLASS BACKBOARD WITH ORANGE TARGET & BORDER

1342B: 42" X 72" RECTANGULAR FIBERGLASS BACKBOARD WITH ORANGE TARGET & BORDER

1342B-BLK: 42" X 72" RECTANGULAR FIBERGLASS BACKBOARD WITH BLACK TARGET & BORDER



1342B

PREMIUM COMPETITION BREAKAWAY GOALS

OUR MASTER 3000 BREAKAWAY GOAL is our top-of-the-line professional level breakaway rim, set to break at 160 lbs. of pressure • Its hefty goal construction creates an unparalleled playing surface for elite basketball programs • Heat-treated ball bearings and steel-hardened springs create a positive lock pressure setting allowing precise fly-back action • Complies with NCAA elasticity rule, and meets NBA and NFHS specifications • Model 3500I meets FIBA specifications for international play.

3000: MASTER BREAKAWAY GOAL WITH NYLON NET

3500I: INTERNATIONAL MASTER BREAKAWAY GOAL WITH NYLON NET



3000

3000 SPRINGS

FIXED PLAYGROUND GOALS

FRONT MOUNT FIXED GOALS offer affordable, yet superior playground performance • Models 240 and 140 are constructed with 18" double rings, 5/8" top ring & 1/2" bottom ring, with dual 1/2" x 15" bracing for ring support • Model 7550 Titan goal is constructed with 18" double rings, 1/2" top ring & 3/4" bottom ring, with one 5/8" support brace • No-tie net attachment allows for ease of installation • All rims feature universal backplates • Fixed rims are not recommended for use with glass backboards • Includes GGN nylon net & hardware.

7550: TITAN PLAYGROUND GOAL WITH NYLON NET

240: SUPER GOAL WITH NYLON NET

140: SUPER GOAL WITH SCN CHAIN NET



7550

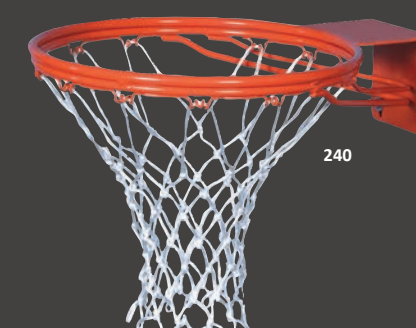

240



39WO

The 39WO & 4039 INSTITUTIONAL FRONT-MOUNT GOALS are economical, multi-use stationary goals • These single-rim goals are a great choice for youth play, practice, or recreational use • Constructed of an 18" single 5/8" ring with single 5/8" x 15" bracing for ring support • No-tie net attachment provides easy installation • Includes GGN nylon net and hardware.

39WO: INSTITUTIONAL GOAL WITH NYLON NET

4039: HIGH STRENGTH INSTITUTIONAL GOAL WITH NYLON NET

ENDURANCE PLAYGROUND GOALS

ENDURANCE GOALS are the toughest playground goals for hard-hitting players • Constructed of 18" double rings with exclusive 3/4" top ring and 5/8" bottom ring • Includes thick, continuous wing brace • T-tie net attachment protects players from hand injury and increases net securement • Includes GGN nylon net and hardware • Endurance goals come standard with Endurance Playground Systems.

8550: ENDURANCE SLAM GOAL WITH NYLON NET

8800: ENDURANCE BREAKAWAY SLAM GOAL WITH NYLON NET



8550

REAR MOUNT GOALS

REAR MOUNT GOALS are designed to increase the lifespan of rear mounted backboards and provide the strongest playground system when used with a rear mount gooseneck or straight post • Unique design means rear mount goals are only compatible with rear mount boards • Rear mount products are designated with a "66" in the part number • Rear mounts are available as single fixed rim (#66T), double fixed rim (#266), or breakaway rim (#6600) • All models include GGN nylon net and hardware.

66T: INSTITUTIONAL REAR MOUNT GOAL WITH NYLON NET



66T

BACKBOARD HEIGHT ADJUSTERS

Bring all ages into the game and make your facility user friendly to even the youngest players, giving them the ability to compete at heights that are fair and fun for them • Our height adjusters lower your backboards to any height between 8' and 10' • The goal height indicator is located on the unit for accurate adjustment • Height adjusters are available with manual or electric operation • Electric height adjusters can be operated using optional remote control, power wand, or by any of our TSC group controllers • All of our height adjusters feature direct goal attachment to transfer any stress and load from the goal to the backstop's structure instead of depending on the backboard for support • Please note, adding height adjusters to existing basketball structures may affect court dimensions.

1130: MANUAL SINGLE POST HEIGHT ADJUSTER SERIES

1125: PORTABLE DRILL FOR MANUAL HEIGHT ADJUSTERS

1170: ELECTRIC SINGLE POST HEIGHT ADJUSTER SERIES

• 1158 Hardwire kit is required for operation, not included in 1170



MANUAL HEIGHT ADJUSTER UNIQUE FEATURE

Spring-activated manual locking mechanism is designed to securely lock the rod into place, eliminating any drifting of the backboard height on all manual height adjusters.



ORANGE ZONE SERVICE AND MAINTENANCE PROGRAM

We're excited to introduce our Orange Zone Maintenance & Service Program! Proper maintenance of your gymnasium equipment is crucial for the safety of players, fans, and personnel, and helps prolong the life of your equipment to ensure years of worry-free use. We've combined our two maintenance and safety programs into one single program for the convenience of our customers. Select dealers and their installation crews are trained and certified to evaluate equipment conditions to identify any issues that may be of concern to the user. This service can be a one time offering, or a yearly contract can be negotiated with the facility.

The Orange Zone program offers three levels to meet the needs of any facility, from a basic visual equipment inspection to thorough hands-on inspections and/or regular maintenance visits through one of our certified dealers.

LEVEL 1 - A visual ground evaluation is done by a factory-trained and certified Gared Performance Sports Systems representative to quickly identify what your equipment may need to maintain a safe environment for your facility users.

LEVEL 2 - A certified Orange Zone dealer performs a thorough hands-on inspection of all safety, structural, and lifting components, including the following:

- Adjust torque settings on structural hardware.
- Inspect all welds.
- Inspect all cables, pulleys, and safety devices.
- Ensure proper alignment of equipment.

LEVEL 3 - Perform complete maintenance of all gymnasium equipment utilizing the findings on the inspection report.



MOTORS AND ACCESSORIES

THE ELECTRIC HOIST is the most convenient way to raise and lower your gymnasium equipment • Direct drive with no dangerous belts or pulleys • Utilized for ceiling and swing up wall mounted basketball backstops • High-strength metal gears • Hardened steel worm gear is captured to take on radial and thrust loads • Our winch is specified to continuously run at the maximum rated load of 1250 lbs/ 566 kilograms for the motors rated duty cycle of 20 minutes without sustaining any gear damage. Our tests show that metal gears consistently outperform other materials under strenuous conditions, especially plastic • Limit switch makes setting the limits a breeze for installers • Once set properly, the limit switch will not lose its critical settings due to vibration or environmental conditions • Powerful, instantly reversing ¾ HP motor (UL listed) is governed to stall at 14 amps • Large grooved drum ensures long cable life and proper coiling • Basic cable care ensures a long, safe life • Precise drum grooves and tension roller guarantee correct cable tracking, even in slack conditions • Positive locking in the double reduction worm gear drive provides for a strong hold under load • Sealed gear case with precision ball bearings and a premium seal for a lifetime of maintenance-free operation • Supplied with single key switch and stainless steel cover • Electrical contractor shall supply all conduit, wiring, junction boxes and other components not listed above • UL Listed.

1194: ELECTRIC HOIST WITH KEY SWITCH

1197: ELECTRIC HOIST WITH WIRELESS REMOTE CAPABILITY

1198: WIRELESS REMOTE TRANSMITTER



THE MANUAL WINCH is engineered and built for high strength and durability for those facilities on a budget • Semi-enclosed, self-lubricating worm gear has heavy-duty capacity for 1,000 lb loads • Efficient 40:1 worm gear ratio • Grooved drum for accurate winding, with a constant pressure roller preventing the cable from climbing the drum ends • Precision thrust bearings provide smooth operation under load • Braking is provided by double self-locking worm gear with a passive uni-directional brake • Maintenance-free gear case offers a lifetime of lifting without hassle • Optimized cable routing close to the wall to reduce stress to winch mounts to ensure a long and safe cable life • Supplied with wood buck for mounting to wall and removable handle for operation • Precision interlocking steel frame for rigidity and precise alignment.

1123: MANUAL WINCH



The SAFSTOP SAFETY LOCKING STRAP is the industry standard for overhead gymnasium safety • Protect players, fans, and personnel with a tested product designed to catch a backstop in the slight chance of winch or cable failure • The Safstop Safety Strap is uniquely manufactured using a multi-pawl design with inertia plate to promote safety in your gymnasium • Attaches to a fixed position on your ceiling-hung or wall mounted backstops to prevent the apparatus from falling if the unit should fail • Universal mounting clamp allows for installation parallel or 90 degrees to the backboard • Positive locking steel pawls simultaneously engage the teeth in the all-steel plate housing.

1100: SAFSTOP SAFETY LOCKING STRAP

THE PORTABLE ELECTRIC WINCH WINDER is the most economic means to power all up fold backstops with manual winches installed • Buy only one portable winch winder and use it for any number of backstops • Features reversing switch enabling the backstop to be raised or lowered without disengaging winder • Geometric right angle drive allows for easy handling • Winch winder has heavy-duty single-phase 115-volt motor.

1119: PORTABLE ELECTRIC WINCH WINDER



MAT STORAGE & CARRIER SYSTEMS

The stationary MODEL 4090/4091 MAT STORAGE SYSTEM easily stores 1 or 2 mats at ceiling level

- Optional sling configurations will store one 42' to 45' mat in a single sling, two 42' mats in one large single sling, or two 42' mats in two individual slings, stacked either vertically or horizontally
- Operated by 2 horsepower, 208/220 volt, 60 cycle, single or three phase or 460/480V/60 HZ, 3-phase instant reverse motors
- Features 50-1 industrial C-face inline helical gear speed reducer and a 20 ft./lbs electric brake
- Please specify voltage, phase, and sling type
- The traveling MODEL 4095 MAT CARRIER SYSTEM offers all of the same features as our standard system, but with the advantage of mobility
- Allows mats to be raised and transported for ceiling level storage or transported to and from balcony or second level storage areas
- Optional sling configurations same as stationary model, plus the ability to transport three 14' x 42' mat sections in an oversize single sling.



MAT HOIST MODEL	TYPE OF LOAD BAR	OPTION	MOVEMENT DIRECTION
4090-A	40' Single Load Bar	A	Stationary Mat Hoist
4090WM-A	40' Single Load Bar	A	Stationary Mat Hoist
4090-DS-B	40' Double Load Bar	B	Stationary Mat Hoist
4090WM-DS-B	40' Double Load Bar	B	Stationary Mat Hoist
4090-DS-C	40' Double Load Bar	C	Stationary Mat Hoist
4090-DS-D	40' Double Load Bar	D	Stationary Mat Hoist
4091-DS-E	20' Double Load Bar	E	Stationary Mat Hoist
4096-A	40' Single Load Bar	A	Forward Moving Mat Hoist
4096-DS-B	40' Double Load Bar	B	Forward Moving Mat Hoist
4096-DS-C	40' Double Load Bar	C	Forward Moving Mat Hoist
4096-DS-D	40' Double Load Bar	D	Forward Moving Mat Hoist
4095-DS-E	20' Double Load Bar	E	Forward Moving Mat Hoist
4097-DS-E	14' Double Load Bar	E	Mini Stationary Mat Hoist
4098-A	40' Single Load Bar	A	Side Moving Mat Hoist
4098-DS-B	40' Double Load Bar	B	Side Moving Mat Hoist
4098-DS-C	40' Double Load Bar	C	Side Moving Mat Hoist
4098-DS-D	40' Double Load Bar	D	Side Moving Mat Hoist

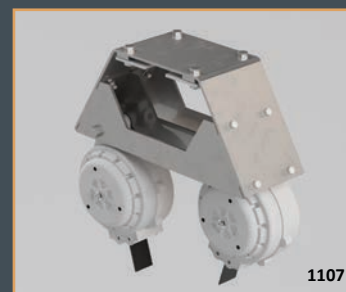
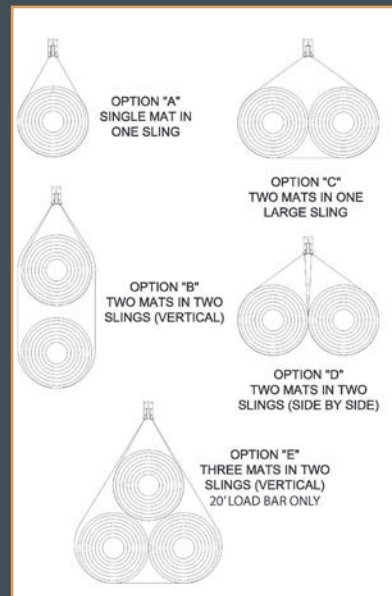

MODEL 1107 MAT STORAGE LOCK safety system is designed to prevent the uncontrolled descent of mat slings due to cable or hoist gearbox failure. In event of unexpected increase in speed, the safety system will immediately lock the sling into its current position.

1107

INDOOR SPORT CAGES

MODEL 4080 MULTI SPORT CAGES are electrically operated practice cages that conveniently suspend from the ceiling structure

- Offered in standard sizes listed below; custom sizes are available to fit your facility needs
- Drive shaft raises and lowers the system powered by our curtain hoist
- Square netting can be raised for entry and exit on all multi-sport nets
- Radius pipe on top of the net is custom
- Standard net color is black.



CAGE MODEL	TYPE OF CAGE	SIZE	NET MODEL	NET SIZE	MESH SIZE	MESH COLOR
4080-70	Multi-Sport	12' H x 12' W x 70' L	4087	12' H x 12' W x 70' L	1-1/8" Square	Black
4080-55	Multi-Sport	12' H x 12' W x 55' L	4086	12' H x 12' W x 55' L	1-1/8" Square	Black
4080-70XL	Multi-Sport	14' H x 14' W x 70' L	4087	14' H x 14' W x 70' L	1-1/8" Square	Black
4080-55XL	Multi-Sport	14' H x 14' W x 55' L	4086	14' H x 14' W x 55' L	1-1/8" Square	Black



MODEL 4080BL BOTTOM LIFT MULTI SPORT CAGES are electrically operated sports cages that suspend from the ceiling

- The bottom of the cage netting is automatically lifted to the top frame, eliminating the need to manually drape the net over the frame before lifting
- Nylon straps hold the top frame at a preset height above the floor during use
- Double cable spools uniformly pull up each side of the lower cage batten frame to within 1'-9" of the structure.

BOTTOM LIFT CAGE MODEL	TYPE OF CAGE	SIZE	NET MODEL	NET SIZE	MESH SIZE	MESH COLOR
4080BL-70	Multi-Sport	12'H x 12'W x 70'L	4087	12'H x 12'W x 70'L	1-1/8" Square	Black
4080BL-55	Multi-Sport	12'H x 12'W x 55'L	4086	12'H x 12'W x 55'L	1-1/8" Square	Black

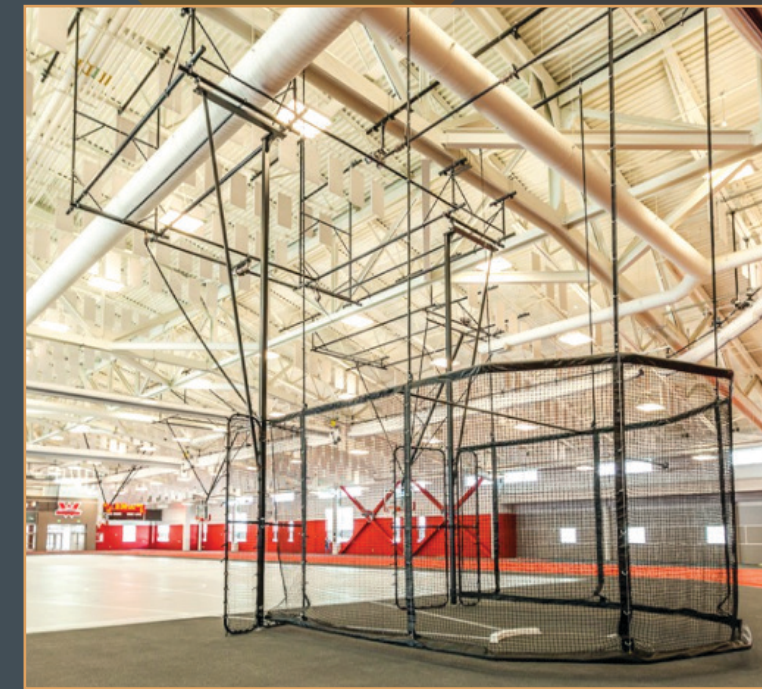

Our MODEL 4075 INDOOR CEILING SUSPENDED THROWING CAGE is a top quality unit for use in facilities where frequent indoor track and field set-up is required

- This product meets all USTF and NCAA requirements for indoor throwing cages
- The net is constructed of 600lb test (minimum), #72 knotted nylon.

The HAMMER THROW DOOR FRAME SYSTEM is comprised of two vertical frame members hinged at the truss connection point to allow frames and wing doors to fold as a single unit

- Frames are 4" square heavy wall tubing, extended to the floor in the down position to support doors in the proper position for the event
- Frames are folded into the stored position by 1/4" galvanized aircraft cable on each vertical frame using a 3/4 HP double drum electric hoist
- Net is constructed of 600lb test (minimum), #72 knotted nylon.

The REAR CAGE FRAME is constructed of 1.9" O.D. heavy wall tubing featuring a cross spreader spans the perimeter of the cage to maintain a 5' distance required by the NCAA rule

- The frame is raised to the overhead storage position by means of six 1/8" galvanized aircraft cables routed through swivel pulleys to a central drive pipe
- The drive system is powered by a 3/4 HP electric motor
- The net is constructed of 600lb test (minimum), #72 knotted nylon.

DIVIDER CURTAINS

4050 CENTER-DRIVE DIVIDER CURTAIN

The CENTER DRIVE CURTAIN offers the same great features as our top roll curtain but goes a step further by eliminating the need for large rollers and extensive overhead attachment • Our unique design uses internal tubular motors synchronized to roll the curtain from the center on our 4" aluminum drive tube.

FEATURES:

- Easy installation and low maintenance.
- Clean design with no belts, cables, or rollers.
- Offers maximum clearance with a 14" profile.
- Fast operation at 26ft/min.
- Includes internal motor brake.
- Includes Safstop safety locking strap.
- **Can be operated using any of our TSC group controllers.**

4020 FOLD-UP DIVIDER CURTAIN

The FOLD-UP CURTAIN provides a cost-effective solution for dividing your gym space.

FEATURES:

- Easy installation.
- 1HP electric operation via key switch, key pad, or wireless remote.
- Includes independent cast aluminum drums.
- Curtain material is 19 oz or 22 oz vinyl lower section and 9oz upper section.
- Vinyl-coated mesh upper section includes welded seams and padded batten with no exposed hardware.
- 2-3/8" diameter centerline continuous drive shaft allows for even curtain balance and load distribution.
- Optional safety device locks drive shaft if speed exceeds 1-1/2" per second.
- **Can be operated using any of our TSC group controllers.**

4020-R RADIUS FOLD-UP DIVIDER CURTAIN

The RADIUS FOLD-UP CURTAIN has the same features as our traditional fold-up curtain, but with a curved design to maximize gym space.

FEATURES:

- Curved design allows separation of running track from center court activities.
- Curtain folds into stored position with a centerline continuous drive shaft for even curtain balance and load distribution.
- **Can be operated using any of our TSC group controllers.**

4040XL TOP-ROLL DIVIDER CURTAIN

The TOP-ROLL CURTAIN features a low profile, making it a smart choice for facilities with height clearance issues.

FEATURES:

- Easy installation and minimal maintenance required.
- Clean design with no belts or cables.
- Includes internal motor brake.
- Maximum clearance with a 14" profile.
- **Can be operated using any of our TSC group controllers.**



4030 ROLL-UP DIVIDER CURTAIN

The ROLL-UP CURTAIN features the automatic operation of a fold-up curtain with a clean, cable-free design.

FEATURES:

- Curtain rolls on the 3-1/2" diameter bottom batten for a smooth, wrinkle-free surface when rolled and in stored position.
- Curtain is driven with 4" wide black polyester webbing.
- Provides a compact 24" clearance in stored position.
- Optional curtain lock safety device locks drive shaft if speed exceeds 1-1/2" per second.
- **Can be operated using any of our TSC group controllers.**

4025 PEAK-FOLD DIVIDER CURTAIN

The PEAK-FOLD CURTAIN'S unique design allows it to fold to the exact contour of sloped ceilings where creative use of space is required.

FEATURES:

- Equipped with 1/8" cables, spaced not more than 10' apart, ending in individual hoist drums.
- Custom-engineered variable diameter cable drums match individual cable travel to the ceiling slope.
- Hoist driven by 1HP, 115 VAC gear motor with overload thermal protection, single-keyed toggle key switch.
- No exposed hardware.
- **Can be operated using any of our TSC group controllers.**

4013 WALK DRAW DIVIDER CURTAIN

The WALK DRAW CURTAIN is a track-style curtain that offers an economical option for facilities that do not require electric operation.

FEATURES:

- Easy installation and minimal maintenance required.
- Curtain moves by manual operation across a 1-7/16" wide enclosed galvanized steel track.
- Carriers are spaced no more than 12" apart with 1" diameter polyurethane wheels.
- Can be stored flat against a wall or in small corners of a facility.

Customize your divider curtain with school pride by adding a customized GRAPHIC option, such as school name, logo, or lettering.

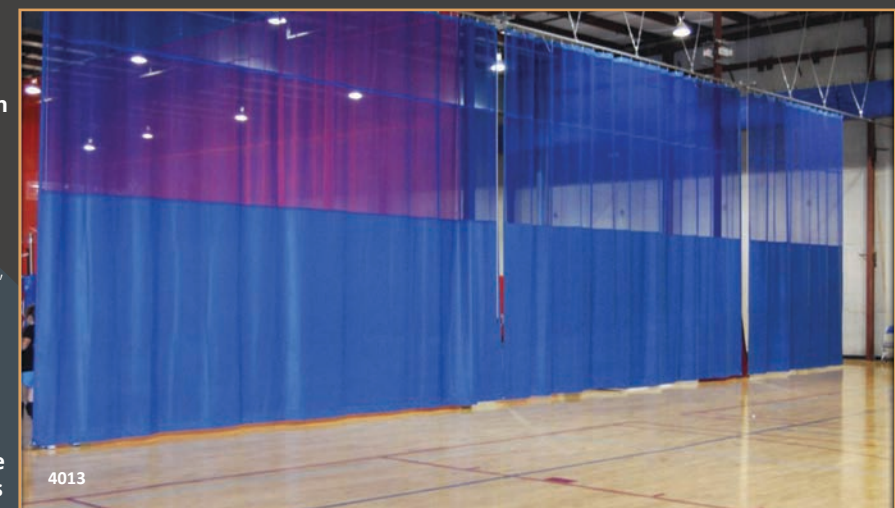

GYMNASIUM DIVIDER CURTAIN PRODUCT GUIDE

MODEL NUMBER	MODEL 4050	MODEL 4040XL	MODEL 4020	MODEL 4030	MODEL 4025	MODEL 4013
STRUCTURE						
DESIGN APPLICATION	Great for all facilities and especially for those with limited clearance height over volleyball courts.	Great for all facilities and especially for those with limited clearance height.	Great for all facilities, especially for those not concerned with clearance height issues.	Great for all facilities, especially for those with limited clearance height.	Great for facilities with pitched or sloped roof structure.	Great for facilities with wall space for stacking curtain when opened.
RECOMMENDED HEIGHT:	20' to 40'	15' to 36'	15' to 60'	15' to 30'	3:12 pitch or under	10' to 30'
RECOMMENDED WIDTH:	20' to 120'	20' to 130'	20' to 130'	20' to 120'	40' to 120'	10' to 80'
PLEASE NOTE: MAXIMUM CURTAIN WIDTH AND HEIGHT ARE DETERMINED BY THE WEIGHT OF THE STRUCTURE. ALL CURTAIN DIMENSIONS SHOULD BE SENT TO GPSS FOR APPROVAL PRIOR TO SPECIFICATION CONSTRUCTION.						
STORAGE DIMENSION:	14"	13.5"	48" (varies)	36"	48" (varies)	10% of (Curtain width +10%)
AVERAGE RUN SPEED:	36 ft per min	18.4 ft per min	6.9 ft per min	8.3 ft per min	18.1 ft per min	N/A
STORAGE TYPE	Roll Up	Roll Up	Curtain Stack	Roll Up	Curtain Stack	Wall Stack
DESIGN FEATURE	No Cables, Belts, Or Rollers, Speed	No Cables Or Belts	Cable Pull	Belt Pull	Stacks Level with Roof	

19 OZ. VINYL COLORS

MARINE	ROYAL	YELLOW	KELLY	ORANGE	NAVY	FOREST	PURPLE
WHITE	BEIGE	BLACK	GREY	RED	BURGUNDY		

9 OZ. MESH COLORS

WHITE	YELLOW	GREEN	RED
BLUE	BLACK	GREY	

22 OZ. VINYL COLORS

ROYAL	GREY	RED

Actual colors may vary slightly from what appears. Contact us to obtain vinyl or mesh samples.

SPEC DETECTIVE™

Gared Performance Sports Systems is excited to introduce Spec Detective, our intuitive part number and specification tool.

PART NUMBER MATCH

Simply type in any manufacturer's part number, and we'll search our database to find the GPSS comparable product, saving you the time and hassle of searching online to find the best sports equipment in the industry.

SPECIFICATION SEARCH

Looking for a complete resource for product information? Just type in a GPSS part number and find everything you need, including specifications, CSI documents, REVIT files, installation manuals, warranties, product images, and more!



GROUP CONTROLLERS

TAKE BACK CONTROL OF YOUR GYMNASIUM EQUIPMENT WITH OUR TSC GROUP CONTROLLERS • The TSC1500XLWIFI GROUP CONTROLLER gives the user the ability to manage their courts conveniently and efficiently, keeping their facility's daily programs running smoothly • Allows one touch operation of basketball backstops, divider curtains, lighting, scoreboards, PA systems or other electrically controlled equipment, now on your smart phone or tablet • This system adds mobility to our wall-mounted touch screen controller, allowing you to monitor your equipment as it operates throughout your gym • The innovative device eliminates the hassle of keeping track of multiple keys, and prevents wasted time setting up each device individually • Includes a single relay box capable of operating 12 devices, and is expandable up to 16 relay boxes until 192 devices are reached • The TSC1500XLWIFI uses an app with your tablet or smart phone showing the equipment layout for each court and any desired scenario of operation • Each device can be operated individually or simultaneously in any direction up or down • Password controlled to prevent unauthorized use • "Press and hold" button feature prevents authorized operator from walking away while equipment is in motion • Features auto shut-off after thirty seconds of non-use • Our WIFI is self contained in our system, eliminating potential downtime if the facility's system is not working • 5" touch screen is included if a smart phone or tablet is not available.



The TSC1500XL TOUCH SCREEN GROUP CONTROLLER unit allows one touch operation of any electrically controlled gymnasium equipment • The TSC1500XL includes a single relay box capable of operating 12 devices, and is expandable up to 16 relay boxes until 192 devices are reached • The system uses a 5.7" touch screen showing the equipment layout for each court and any desired scenario of operation • Each device can be operated individually or simultaneously in any direction up or down • Features manual control override with 15' cord, which is to be used at the relay panel as a back-up to the touch screen • The system is password controlled to prevent unauthorized use • "Press and hold" button feature prevents authorized operator from walking away while equipment is in motion • Features auto shut-off after thirty seconds of non-use.

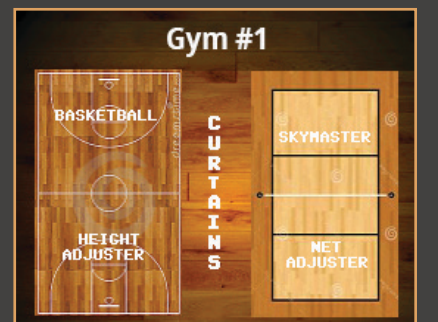
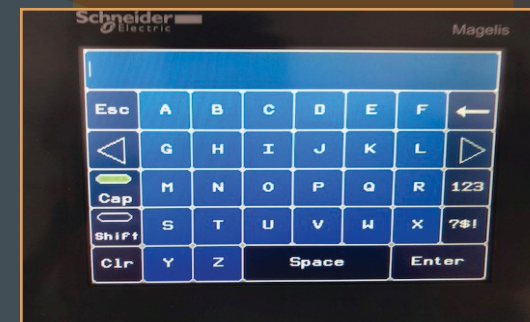

The MODEL TSC1500 KEYPAD GROUP CONTROLLER is an economical option for the operation of basketball backstops, divider curtains, lighting, scoreboards, public address systems or just about any other electrically-operated equipment through a wall-mounted keypad • Unlike the more advanced TSC models, the TSC1500 does not require factory preset programming, so all functions can be conveniently programmed in the field • This system is a great low cost alternative for new or retrofit gymnasium installations • Features singular device operation and multiple device operation in groups of up to eight devices • Can control a maximum of 160 devices • Can handle a total of 75 possible moving groups and can operate 50 auxiliary devices • Includes power panel back up operating system and less electrical wiring is required • The device is passcode protected and no keys are required.



WALL PADDING

Our WALL PADDING protects players from contact in heavy play environments, such as behind basketball backstops and in wrestling rooms or workout areas • We offer a vast selection of padding choices, from walls to stages to custom structures • Our specifications meet or exceed the industry safety standards • All wall padding is covered in 14 oz. polyester laminated vinyl that is rot, mildew, & fungus resistant and passes the rigorous ASTM E84 flame resistance testing method required by today's stringent fire safety codes • Vinyl is fully wrapped over your choice of foam (see page 19 for model numbers) and adhered to a 7/16" OSB board to provide a time-tested combination to keep your play area an impact safe zone.



14 OZ. VINYL COLORS

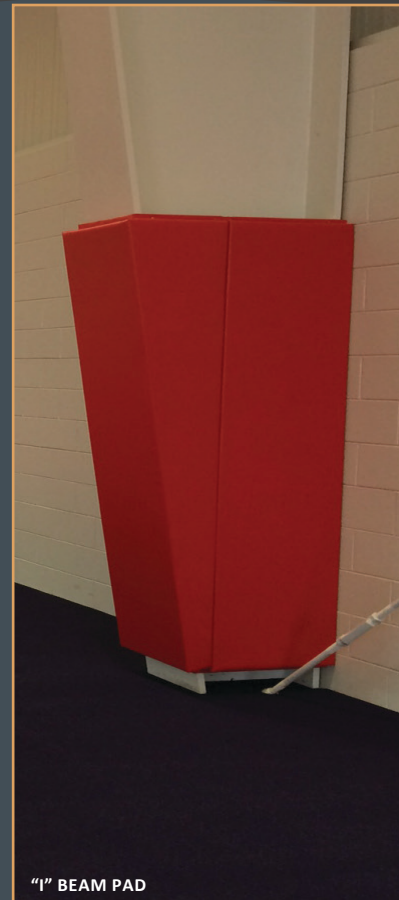

"1" BEAM PAD

WALL PAD PRODUCT GUIDE

PAD SERIES	DEFENDER	IMPACT DEFENDER	FIRE DEFENDER	FIRE DEFENDER II	FIRE DEFENDER III	ULTRA DEFENDER
FOAM INNER						
FLAT PAD MODEL #	MODEL 4110	MODEL 4120	MODEL 4130	MODEL 4131	MODEL 4132	MODEL 4133
APPLICATION	For spaces with minimal impact, light play, & walls that are further than 6 ft from play.	For areas with highest play levels and when walls are less than 6 ft from play.	Same specs as Model 4110, but also used where fire code requires either ASTM certification.	For areas with medium play levels & walls are more than 6 ft from play & require either ASTM certification.	For spaces with moderate play levels & walls are more than 6 ft from play & require either ASTM certification.	For areas with extreme play levels & walls are more than 6 ft from play & require either ASTM certification.
FOAM TYPE	Poly-urethane Foam	Bonded Foam	Medium Neoprene Foam	Firm Neoprene Foam	X-Firm Neoprene Foam	XX-Firm Neoprene Foam
FOAM THICKNESS	2" Standard (additional thickness available)	2" Standard (additional thickness available)	2" Standard (additional thickness available)	2" Standard (additional thickness available)	2" Standard (additional thickness available)	2" Standard (additional thickness available)
VINYL TYPE	14 or 19 oz. CSFM, NFPA701 Certified	14 or 19 oz. CSFM, NFPA701 Certified	14 or 19 oz. CSFM, NFPA701 Certified	14 or 19 oz. CSFM, NFPA701 Certified	14 or 19 oz. CSFM, NFPA701 Certified	14 or 19 oz. CSFM, NFPA701 Certified
BACKER	7/16" OSB	7/16" OSB	7/16" OSB	7/16" OSB	7/16" OSB	7/16" OSB
ASTM E84 CERTIFIED			✓	✓	✓	✓
ASTM F2440 CERTIFIED		✓				✓
NFPA 286 CERTIFIED			✓	✓	✓	✓

CEILING-HUNG FOOTBALL GOALPOSTS

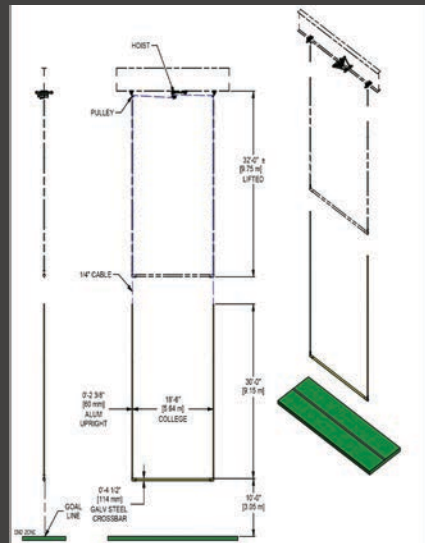
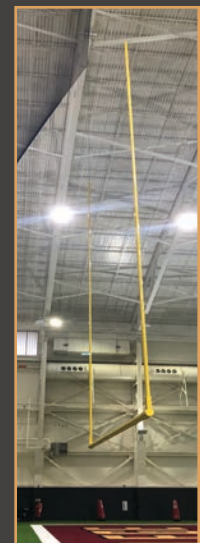

MODEL FGP002 CEILING-HUNG RETRACTABLE FOOTBALL GOALPOSTS electrically retract up to the ceiling, allowing facilities to maximize their space • Great choice for practice facilities and multi-use gyms • Each goalpost consists of a 4-1/2" O.D. galvanized steel crossbar that is 18' 6" wide to meet collegiate football specifications • Uprights are 2-3/8" O.D. heavy wall aluminum tubing, spanning 30' in height • Crossbar and uprights are powder-coated in white or yellow to withstand heavy play environments • Goalposts conveniently raise up to the ceiling with our 1194 electric hoist with key switch • Goalposts are sold in pairs.

P.E. EQUIPMENT

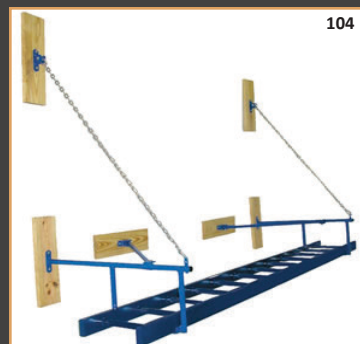

MODEL 104 HORIZONTAL LADDER is constructed of 1-5/8" diameter heavy wall tubing • Support frame is fastened to 2" x 6" wood boards sealed and varnished that are mounted to the wall • Ladder rungs are 1" diameter steel tubing • Includes grey powdercoat finish.

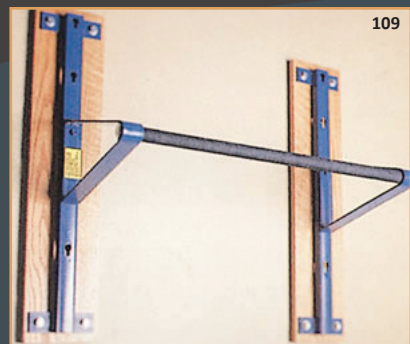

MODEL 109 ADJUSTABLE HEIGHT CHIN UP BAR is constructed with steel frame rails and a welded steel movable bar structure • 1" diameter bar is adjustable to four different heights using keyhole slots • Includes grey powdercoat finish.



MODEL 108 ARM LADDER is constructed with 15/16" diameter heavy wall tubing • Support frame is fastened to 2" x 6" sealed & varnished wood boards mounted to the wall on 22" centers • Grid rungs are 1" diameter steel tubing spaced 8" apart • Includes grey powdercoat finish.



Our **CLIMBING ROPES** are available in manilla, polypro, or polyplus rope material type • Choose braided, whipped, turk knot, or poly boot end • Standard length is 18' with custom lengths also available • Hardware attachments and accessories are available; call for more information.



MODEL 106 GRID CLIMBER is constructed of 15/16" diameter heavy wall tubing • Support frame is fastened to 2" x 6" wood boards sealed and varnished that are mounted to the wall on 31 5/16" centers • Grid rungs are 1" diameter steel tubing • Includes grey powdercoat finish.



MODEL 105 PEG BOARDS are 2" thick hardwood finished with three coats of clear varnish • Two hand-grip pegs are furnished for each board • Peg boards are available in the following sizes: Advanced Elementary (24" x 24"), Junior/Senior HS (28" x 28"), Vertical HS (12" x 72"), and High School/Collegiate (31" x 31").

PORTABLE BASKETBALL SYSTEMS

Our tradition of quality and innovation in the portable basketball market began on the drafting tables of our engineering team over 100 years ago, and we haven't looked back since! From our industry changing invention of the Hydra-Goal in 1980, the first ever arena portable system, to our introduction of the popular Pro S spring-balanced competition portable in the 2000s, we've been continually revolutionizing the portable basketball market. Today we are proud to offer a full line of competition portable systems for every facility type and play level, many of which can be seen in professional arenas and NCAA Division 1, II & III schools across the U.S. and all over the globe. View our complete line of portable basketball systems and accessories at WWW.GAREDPERFSPORTS.COM.

PRO: COMPETITION ARENA PORTABLE SYSTEM

The PRO is the finest engineered competition portable in the world, available with either spring-assisted or electric operation • Electric operation raises and lowers the unit with the flip of a switch, while spring-assisted models provide balanced and effortless manual lifting and lowering of unit • Newly designed system features a more compact base with 360 degree wheels and forklift slots for easy transport in small spaces • Broadcast and multi-media ready with outlet receptacles and channels for wire concealment • Complete system includes regulation 72" glass board, model 3500 breakaway rim, and PMCE bolt-on board padding • 1200 lbs ballast weight included and concealed in unit base • Boom padding and floor anchoring system are included • Fully customizable, with shot clock supports and other accessories sold separately • Meets NCAA, NAIA, NFHS and NBA main court specifications and is approved by FIBA for high level international competition • **10 YEAR LIMITED WARRANTY ON ALL PARTS, LIFETIME LIMITED WARRANTY ON BACKBOARD INCLUDED WITH THE UNIT, 5 YEAR LIMITED WARRANTY ON PRO-MOLD® PADS AND 4 YEAR ON BREAKAWAY GOAL.**

9718E: PRO PORTABLE BASKETBALL SYSTEM WITH ELECTRIC ACTUATOR

9718S: PRO SPRING-ASSISTED PORTABLE BASKETBALL SYSTEM



HOOPMASTER®: VERSATILE SPRING-BALANCED PORTABLE SYSTEM

This state-of-art portable basketball system uses tension spring technology for easy use and operation • The maintenance-free tension spring mechanism has been engineered for balanced and effortless lifting and lowering of the unit and the springs are concealed inside the base for safety and appearance • System includes regulation 72" glass board, model 2500 breakaway rim, and PMCE bolt-on board padding • 1000 lbs ballast weight included and concealed in unit base • Boom padding and floor anchoring system are included • Designed for main court play in university, high school and pro arenas • Approved by FIBA for Level 3 international competition • **10 YEAR LIMITED WARRANTY ON ALL PARTS, LIFETIME LIMITED WARRANTY ON BACKBOARD INCLUDED WITH UNIT, 5 YEAR LIMITED WARRANTY ON PRO-MOLD PADS AND 4 YEAR ON BREAKAWAY GOAL.**

9408: HOOPMASTER® PORTABLE BASKETBALL SYSTEM WITH 8' BOOM

9405: HOOPMASTER® PORTABLE BASKETBALL SYSTEM WITH 5' BOOM



HOOPMASTER® LT: THE PORTABLE OF CHOICE FOR SIDE COURTS AND INTRAMURAL PLAY

The traditional style of the HOOPMASTER® LT offers more features and structural strengths than any similar size basketball portable backstop available on the market • A unique tension spring mechanism allows for effortless lifting and lowering of the unit • Adjustable at 8', 9' and 10' heights, the portable comes with an official size (42" x 72") shatter proof glass backboard, our original PRO-MOLD® backboard padding, and a positive lock breakaway goal • The base is fully padded on three sides with vinyl covered high density polyurethane foam • An anchoring system is included with the unit • Full weight with ballast 1700 lbs. (771 kgs) • **10 YEAR LIMITED WARRANTY ON ALL PARTS, LIFETIME LIMITED WARRANTY ON BACKBOARD INCLUDED WITH THE UNIT, 10 YEAR LIMITED WARRANTY ON PRO-MOLD® PADS AND 4 YEAR ON BREAKAWAY GOAL • PLEASE NOTE: OUTDOOR USE AND STORAGE VOIDS WARRANTY AND REQUIRES GALVANIZED UPCHARGE FINISHING.**

9305: HOOPMASTER® LT PORTABLE BASKETBALL SYSTEM WITH 5' BOOM

CEILING-HUNG VOLLEYBALL SYSTEMS

THE SKYMASTER® Ceiling-Hung Volleyball System eliminates the need for transporting volleyball equipment, while also saving storage space • This innovative design allows you to electrically raise your entire system up and out of the way of other court activities in just minutes • Everything needed to play is included with the system, including upright pads and premium net • Available in one, two, or three-court configurations • 25 YEAR LIMITED WARRANTY ON STRUCTURE, 5 YEAR LIMITED WARRANTY ON WINCH ASSEMBLY.

SKYMASTER® CEILING-HUNG VOLLEYBALL SYSTEM FEATURES:

- 4" square powdercoated steel support structure
- 1HP dual drum direct drive electric hoist
- Rail system provides infinite net height adjustment for volleyball, badminton, & tennis.
- Easy-to-operate ratchet winch has folding handle for safe adjustment
- Includes antennas, sideline markers, and cable covers
- Safety straps are included for added safety
- Optional feature: Electric Net Height Adjustment

8001: SKYMASTER® ONE-COURT VOLLEYBALL SYSTEM

8001R: SKYMASTER® ONE-COURT VOLLEYBALL SYSTEM & PADDED REFEREE STAND

8002: SKYMASTER® TWO-COURT VOLLEYBALL SYSTEM

8002R: SKYMASTER® TWO-COURT VOLLEYBALL SYSTEM & PADDED REFEREE STAND

Our SKYMASTER® SUSPENDED CEILING-HUNG VOLLEYBALL SYSTEM has uprights securely suspended in the air with almost 3 feet between bottom of post and floor, making it ideal for competition play • Available with or without referee stand, and in one, two, and three-court configurations.

8101: SKYMASTER® SUSPENDED ONE-COURT VOLLEYBALL SYSTEM

8101R: SKYMASTER® SUSPENDED ONE-COURT VOLLEYBALL SYSTEM & PADDED REFEREE STAND



3" O.D. CARBON FLARE™ TELESCOPIC VOLLEYBALL SYSTEM

After listening to feedback from facility managers and coaches, we're excited to introduce our Carbon Flare™ Telescopic Volleyball System • This competition system is constructed with carbon fiber posts that are much lighter than aluminum posts for easy set-up, yet five times stronger than steel to withstand the heavy play of elite volleyball programs • 3" telescopic uprights are powder-coated black for a sleek look and feature our Precision Gear™ worm gear winch for smoother operation, and new curved post caps that prevent strap damage • The complete system includes two uprights with pads, competition net, antennas and sideline markers, and floor sleeves with cover plates • The system meets all NFHS and NCAA specifications for official volleyball play.

5300: CARBON FLARE™ TELESCOPIC ONE-COURT VOLLEYBALL SYSTEM

INGROUND VOLLEYBALL SYSTEMS

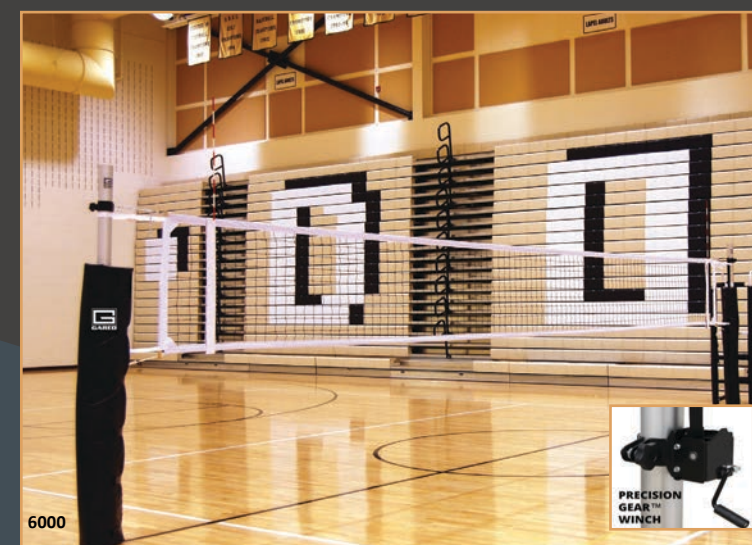
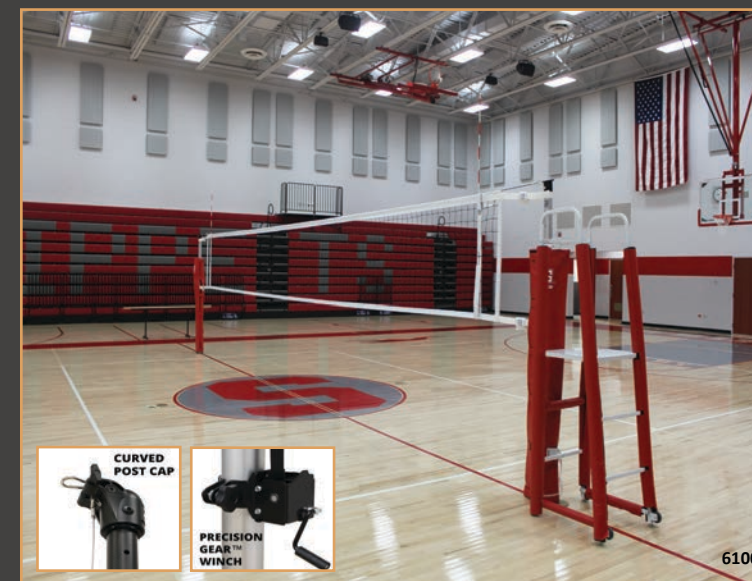

3-1/2" O.D. RALLYLINE™ TELESCOPIC VOLLEYBALL SYSTEM

Best-selling competition volleyball system with quick and easy set up with preset heights utilizing our unique pin-lock mechanism • The telescopic tube raises and lowers easily with the spring assist operation for men's, women's and junior's play • Our innovative top cap allows the winch strap to move effortlessly over the post to reduce strap damage and for easy net attachment • The 3-1/2" O.D. telescopic uprights are constructed of a strong, yet lightweight anodized extruded aluminum for superior support and long life • Easy-to-operate winch sets net tension • New 3-point net attachment makes set up quick and easy • Post bottoms feature adjustable, non-marking pads • Meets USVBA, NCAA, and NFHS competition specifications.

6100: RALLYLINE™ TELESCOPIC ONE-COURT VOLLEYBALL SYSTEM

3-1/2" O.D. RALLYLINE™ MULTI-SPORT VOLLEYBALL SYSTEM

Extremely versatile and economical aluminum volleyball system offering the most complete line of net sports all within one system • With easy-to-use slide collars, the net is infinitely raised and lowered to any height • Unique pin-lock mechanism allows posts to adjust to Men's (7' 11-5/8"), Women's (7' 4-1/8"), and Junior's (7') net heights • The 3-1/2" O.D. lightweight high strength aluminum posts with anodized finish provide dependable performance and years of worry-free use • Bottoms of uprights feature adjustable, non-marking pads • Meets USVBA, NCAA, and NFHS competition specifications.

6000: RALLYLINE™ MULTI-SPORT ONE-COURT VOLLEYBALL SYSTEM

3" O.D. OMNI-STEEL™ TELESCOPIC VOLLEYBALL SYSTEM

Steel competition volleyball system offers a traditional design with unmatched strength and support for all levels of volleyball play • Durable 3" O.D. telescopic steel posts include a sleek black powdercoat finish • Features hassle-free net height adjustment with our pin-lock mechanism for men's, women's, and juniors net heights • Engraved markings on telescopic post indicate height • Internal spring system keeps telescopic post from free falling inside the base post when the pin lock is removed • Net Glide System easily glides the net cable over the post to the ratchet winch for tensioning • Meets USVBA, NCAA, and NFHS competition specifications.

5100: OMNI-STEEL™ TELESCOPIC ONE-COURT VOLLEYBALL SYSTEM



VOLLEYBALL PADDING

VOLLEYBALL UPRIGHT SAFETY PADDING protects players from injury due to contact with uprights during play • 6' high pads are comprised of 1-1/4" thick urethane foam covered in 14-oz. vinyl-coated nylon • Pads contain horizontal Velcro straps for secure closure around uprights • See color chart for color availability for stocked and non-stock colors • Two pads are included when complete GPSS system is purchased • Meets NCAA, NFHS, & international specifications for competition play.

6010: VOLLEYBALL UPRIGHT SAFETY PAD (SPECIFY COLOR)

6020: VOLLEYBALL CENTER UPRIGHT SAFETY PAD (SPECIFY COLOR)



REFEREE STANDS AND PADDING

Our versatile REFEREE PLATFORM can be used as fixed or free standing • "V" brackets allow attachment directly to post with Velcro® straps • Legs are fully height adjustable with protective bottom caps • Two non-marring wheels allow for easy transport • Ref stand padding is constructed of dense foam covered with reinforced vinyl and Velcro attachment for quick set up • See charts for pad colors • Padding sold separately.

6446: REFEREE STAND

6448: COLLAPSIBLE REFEREE STAND

6040: REFEREE STAND SAFETY PAD

VOLLEYBALL EQUIPMENT STORAGE CART will easily store uprights, referee stand, and pads • Contains three durable hooks on each side to store a total of six uprights • Shelf on bottom can store bigger items, such as a folded referee stand • Nylon basket also holds other items such as net, antennas and volleyballs • Entire cart is powdercoated white • Non-marring casters roll easily for convenient transport on and off the court.

6295: VOLLEYBALL EQUIPMENT STORAGE CART



INDOOR PICKLEBALL SYSTEMS

Our sleeved system is a smart choice for indoor facilities requiring pickleball and badminton play on a single system • Sleeved system includes two floor sleeves with cover plates • Bagged portable system allows for transport in storage bag and includes paddles and balls, making it perfect for leagues and recreational use • All systems include two powdercoated posts and a 21' net.

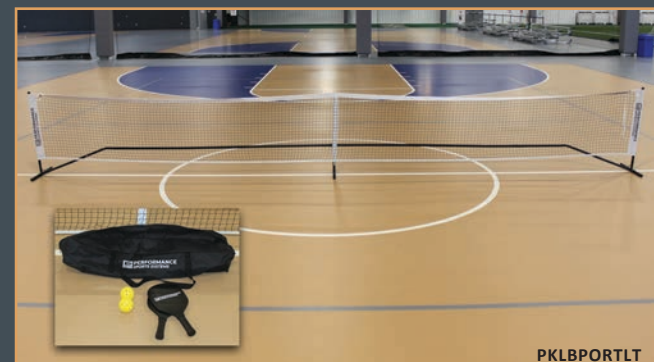

VOLLEYBALL ACCESSORIES

VOLLEYBALL FLOOR SLEEVES are constructed of heavy-gauge steel for maximum support of volleyball uprights in indoor facilities • Allow uprights to be removed and stored out of the way of other court activities • Designed for use with floating and non-floating synthetic floors • Choose 4", 3-1/2", or 3" inside diameter.

6405: 4" O.D. X 12" DEEP FLOOR SLEEVE

6400: 3-1/2" O.D. X 10" DEEP FLOOR SLEEVE

6404: 3" O.D. X 9" DEEP FLOOR SLEEVE

COVER PLATES are constructed of a durable brass or chrome alloy with a concealed hinge for covering existing floor sleeves • All attachment screws are concealed when closed for a safe and flat playing surface • Standard covers have a 5" O.D. with total diameter of 6-1/4" • Oversized covers have a 6-5/8" O.D. with total diameter of 8".

ABOVE FLOOR SLEEVES are used with floor anchors when floor will not accept traditional inground floor sleeves • T-type base eliminates need for cables or rigid supports • Anchor included; choose from anchor styles below • Compatible with all GPSS volleyball systems.

BOLT-ON SECOND STORY FLOOR SLEEVE ADAPTER allows for standard floor sleeves on every level of your facility • Unit bolts to underside of concrete or beam to allow use of normal floor sleeves • Constructed of 6-5/8" O.D. heavy-gauge steel and .156 wall tubing and steel channels for ultimate support • Adapter measures 6" O.D., for use with all sleeves • Compatible with all GPSS volleyball systems.

CUSTOM BASE ADAPTERS allow your facility to upgrade to GPSS volleyball systems without replacing your existing floor sleeves • Custom-designed to retrofit any floor sleeve • Specify diameter and depth of existing floor sleeve when ordering.

FLOOR ANCHORS allow installation of above floor sleeves for facilities where access or floor structure is not ideal for use of inground floor sleeves • Anchors are installed flush playing surface for safety • Choose from four anchor types based on floor type.

MODEL #	STYLE	FLOOR TYPE APPLICATION	WEIGHT (LBS)	WEIGHT (KGS)
1015-12-00	Style B	Wood over concrete	1	.5
1026-12-00	Style BX	3 1/4" Anchor wood over concrete	1	.5
1020-12-00	Style C	Concrete or synthetic	1	.5
9112	Style E	Wood resting on sleeper or metal clips	1	.5

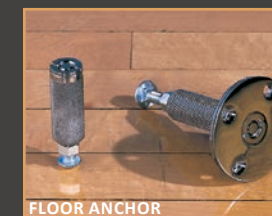

INDOOR BADMINTON SYSTEMS

Our SLEEVED BADMINTON SYSTEM is ideal for recreational and competition play • Constructed of 1-1/2" square steel-tubed uprights, powdercoated white • Designed to be installed into floor sleeves for removal when not in use • Includes adjustable foot pad to set net height • One court system includes (2) uprights, (2) floor sleeves with cover plates, and (1) 21' badminton net.



6619: ONE-COURT SLEEVED BADMINTON SYSTEM

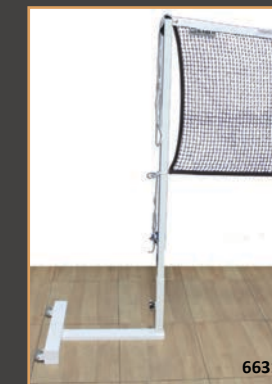

PORTABLE BADMINTON SYSTEMS offer a mobile alternative to traditional sleeved systems • Model 6631 is constructed of 1-1/2" square steel-tubed uprights with weighted base and T-bar for stability, supported by solid rubber caster wheels • Model 6640 is constructed of 2-3/8" round uprights with beefy 160 lb weighted base with T-bar, supported by 5" diameter urethane wheels • All portable systems include a 21' x 2-1/2' official badminton net.

6631: ONE-COURT PORTABLE BADMINTON SYSTEM

6640: ONE-COURT HEAVY-DUTY PORTABLE BADMINTON SYSTEM WITH 160 LB BASE

OUTDOOR BASKETBALL SYSTEMS

Are you building an outdoor basketball court, but unsure where to begin? When searching for an outdoor system, consider factors such as play level, weather elements, and budget. We make it easy by combining our popular post, backboard, and goal models in three different levels of gooseneck and adjustable packages so you can choose the system that's perfect for your outdoor court!

GOOSENECK PACKAGES

These complete packages feature our round steel gooseneck post with fixed height • Choose a budget-friendly Economy Package with a 3-1/2" post for light play, or a Standard Duty Package which includes our best-selling 4-1/2" O.D. post • Our Heavy Duty Packages include a beefy 5-9/16" or 6-5/8" post for heavy play or urban settings • Each package level features several board and goal styles to fit any park or playground application.



STRAIGHT POST PACKAGES

Our adjustable post packages include our round steel straight post with adjustable extension arm to allow for all-age play • Backboard braces provide maximum board stability and are included with all straight post packages • Choose a budget-friendly Economy Package with a 3-1/2" post for light play, or a Standard Duty Package which includes our best-selling 4-1/2" O.D. posts • Heavy Duty Packages include beefy 5-9/16" or 6-5/8" posts for heavy play or urban settings • Each package level features several board and goal styles to fit any park or playground application.

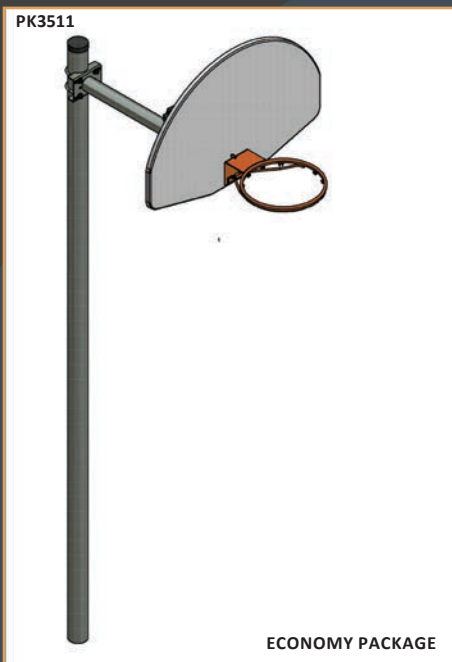

ENDURANCE® PLAYGROUND BASKETBALL SYSTEMS

Our popular Endurance® Playground Basketball Systems were developed specifically for those hard-hitting players who demand outdoor systems that can withstand powerful dunks and long, intense games. These systems were rigorously tested by our engineering team for post deflection, backboard vibration, structural integrity, and load capacity, outperforming in every category to deliver the strongest and most uncompromising outdoor basketball systems available today.

FEATURES:

- 6" x 6" square steel inground post, 1/4" thick Schedule 40 steel
- Exclusive triangular extension arm & thick bracing provide maximum board stability.
- Enduracoat™ technology protects post by galvanizing first, then powdercoating black for ultimate protection.
- Choose either steel, glass, acrylic, or polycarbonate backboard in 42" x 60" or 42" x 72" size.
- Post and backboard padding are optional & recommended.
- Limited Lifetime Warranty on all post components.



ADJUSTABLE BASKETBALL SYSTEMS

Play like the pros with our complete line of GP SERIES ADJUSTABLE BASKETBALL SYSTEMS! Superior actuator mechanism allows rim height to easily adjust from 7' to regulation 10', making it easy for all ages to raise and lower the system • Square heavy-gauge steel post with 3/16" wall thickness provides superior strength and is powdercoated black for weather protection • Surface mount post design allows for no-hassle installation and portability • Heavy tubular lower arm provides a direct-goal attachment for backboard and rim • Backboard braces extend to the outer corners of the backboard, allowing for a clear, unobstructed view • Board features a white target and border for a professional look • Heavy-duty breakaway goal with nylon net stands up to any level of competitive play • Premium board and pole padding are optional and recommended for player safety.



STRIKER 4" PORTABLE SOCCER GOALS

Score the golden goal with our premium TOUCHLINE™ STRIKER SOCCER GOALS • The 4" extruded powdercoated aluminum frame is lightweight for ease of assembly and transport, with welded one-piece goal frame corners providing strength and rigidity with no visible hardware • Crossbar, uprights, and ground bar all contain a continuous channel to keep net securely fastened around the entire goal and prevent errant balls • 8' x 24' size meets NCAA, NHSAA, and FIFA specifications • Goals are available with either round or square frame • Available in 8' x 24', 7' x 21', and 6' x 12' sizes to fit every program's competition or recreational needs • Goals are sold in pairs and include nets.



SGRD824SPT



ALL-STAR 4" PORTABLE SOCCER GOALS

Our line of TOUCHLINE™ ALL-STAR SOCCER GOALS are a great choice for any level of soccer play • Extruded powdercoated 4" aluminum frame is lightweight for ease of assembly and transport, with welded one-piece goal frame corners providing strength and rigidity with no visible hardware • Crossbar and uprights contain a channel along the backside of the goal for easy and secure net attachment • Heavy-duty 1-5/8" galvanized steel backstays and adjustable one-piece ground bar adds counterweight and stability to goals • Official 8' x 24' size meets NCAA, NHSAA, and FIFA specifications • Goals are available with round, square, or rectangular frame in 8' x 24', 7' x 21', 6-1/2' x 18', and 6' x 12' sizes • Goals are sold in pairs and include nets.



SGRD824PT WITH SGWK WHEEL KIT



SGRT721PT

GALACTICO 3" PORTABLE SOCCER GOALS

GALACTICO 3" SOCCER GOALS have all the same features as our All-Star goals, but with smaller 3" extruded powdercoated aluminum frame as a budget-friendly option for rec leagues, youth play, practices, or home use • 3" goals available with round frame only • Available in 8' x 24', 7' x 21', 6-1/2' x 18', 6' x 12', 4-1/2' x 9', and 4' x 6' sizes • Goals are sold in pairs and include nets.



SG3RD459PT

SOCCER ACCESSORIES



SGCF CORNER FLAGS

SGSA ANCHORS

SGUA

SGWK WHEEL KIT

HEX MESH NETS

FOOTBALL GOALPOSTS

Our FOOTBALL GOALPOSTS are unyielding for the toughest high school, college, or recreational play environments • Newly redesigned with enhanced features for easier assembly and installation (some drilling in the field is required) • Your choice of our popular 4-1/2" O.D. gooseneck with 5' offset, or our ultra-duty 5-9/16" O.D. gooseneck with 6' offset • Crossbar is 3-1/2" O.D. and top uprights are 2-3/8" O.D. and 20' tall for all models • Crossbars are 23' 4" apart for high school specifications and 18' 6" apart for college specifications • All models available with your choice of galvanized, yellow, or white powdercoat • All models available for permanent, sleeve-mounted, or plate-mounted installation • Goalposts meet all NCAA and NFSHSA specifications and are sold in pairs • Optional ground sleeves are available for sleeve-mount models to allow removal during off season • 4" thick protective post pads are optional and recommended for safety.



FGHS45IGY



FGP200

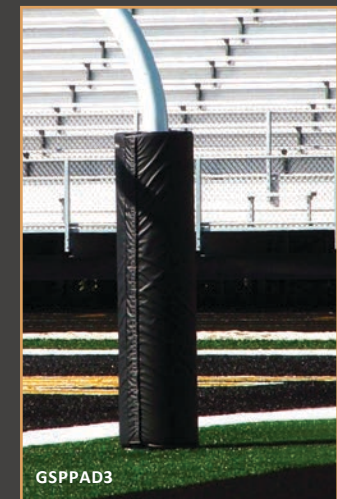

GSPPAD3

BASEBALL CAGES & FOUL POLES

OUTDOOR BATTING AND MULTI-SPORT CAGES are a great addition to any baseball field, practice facility, training camp, or driving range • Available in 55' and 70' lengths to fit your space requirements • All cages include 3-1/2" O.D. posts in your choice of aluminum for rust-resistance, or galvanized steel for superior strength • Posts measure 12' from ground to top of post and are installed in a permanent concrete footing • Nets measure 10' in height when assembled, with 2' draped on the ground, and attach with rope and pulleys to pull into desired position • Nets are sold separately.



4086-55 WITH 4088 NET



BSPOLE-20P

Complete your baseball field with our premium line of BASEBALL FOUL POLES • Poles are constructed of heavy-duty galvanized steel and include an 18" wide steel mesh wing panel • Entire unit is galvanized and powdercoated in optic yellow for maximum protection • Poles available in 3-1/2" and 5-9/16" O.D. and 12', 15', 20', and 30' heights to meet any program's needs and budget requirements • Pole heights measured from ground level to top of pole; inground poles will be longer for mounting in concrete footing • Ground sleeves are optional for inground (P) models and must be ordered with the poles • All foul poles are sold in pairs.

LACROSSE GOALS

SLINGSHOT™ PORTABLE LACROSSE GOALS will satisfy the needs of any lacrosse program in this rapidly growing sport • Official 6' x 6' goal is ideal for competition play, leagues, practice, and recreational use • Uprights and crossbar are constructed from heavy-gauge galvanized steel for ultimate strength, and the one-piece welded face construction with mitered corners provides a clean look • Thick flat steel groundbar provides added stability and reduces ball deflection • Entire goal has an orange baked-on powdercoat finish for maximum protection • Simple six-piece goal construction allows for no-hassle assembly, with lacing cord included for attaching net • Each goal includes four ground stakes • Goals meet all NCAA and high school specifications • Sold in pairs, nets are included.



LG200

OUTDOOR VOLLEYBALL SYSTEMS

OUTDOOR VOLLEYBALL STANDARDS are ideal for competition play, leagues, or recreational use, making them a great choice for parks, schools, beaches, and campgrounds • Nets are sold separately for all outdoor volleyball systems • Use model ODVBNET for 28' net or model ODVBNET32 for 32' long net.



ODVB

ROUND POST SYSTEMS

- Choice of standard 2-3/8" or heavy-duty 3-1/2" O.D. galvanized steel posts.
- 10' uprights with 20" in ground for stability.
- Posts are pre-drilled for volleyball or badminton net height.
- Ground sleeves and caps included for semi-permanent installation.
- Upgrade to #6827 locking cap to prevent unauthorized use.



ODVB40SQ

SQUARE POST SYSTEM

- Includes two 4" square extruded aluminum uprights, powdercoated white for extra protection, especially in coastal areas.
- Net rails provide infinite net height adjustment.
- Ground sleeves and caps are sold separately.
- Beach conversion kit allows for play in sand (Model 6815) and is sold separately.

MONGOOSE® WIRELESS VOLLEYBALL SYSTEM

The MONGOOSE® WIRELESS VOLLEYBALL SYSTEM is versatile and portable for play in grass, sand, or indoors, making it ideal for institutional as well residential use • The exclusive tension-operated design and patented two-stake inground plate system means no dangerous guy wires for players to trip over • High-strength telescopic aluminum poles provide weather protection and have pins that can be easily adjusted for Men's, Women's, and Junior's net heights • Durable protective post padding included to protect players from injury • Installation is quick and easy and requires only a hammer • Complete system comes in a durable nylon carrying bag for easy transport • Sand wedge adapters included for beach play • Indoor conversion kits sold separately.



7900



TENNIS SYSTEMS

Our TENNIS POSTS are comprised of 3" round steel with integral lacing bars and include brass winder • Posts are powdercoated in choice of green or black, and are designed for permanent installation • Posts sold in pairs, nets and ground sleeves sold separately • Center strap and anchor are available for maximum net securement.



GSTNPERD
GSTNETAUS

PICKLEBALL SYSTEMS

We have everything you need for PICKLEBALL, the fastest growing sport in the country • The PKLBIG Outdoor Inground Pickleball System is designed for maximum strength and durability in park settings • 3" round tubular steel posts are powdercoated in your choice of green or black • System includes a regulation 21' 9" mesh net and ground sleeves for post removal during off season • See Page 24 for indoor pickleball systems.



PKLBIG

BLEACHERS

SPECTATOR BLEACHERS provide high-quality seating for fans and visitors at schools, athletic complexes, parks, fairgrounds, gyms, and amphitheaters • All bleachers include 10" anodized aluminum seat planks and 10" aluminum foot planks, with durable aluminum angle framing for maximum support • Double foot planks provide maximum leg room for spectators and are available for all models.

TIP 'N ROLL BLEACHERS

TR SERIES TIP 'N ROLL BLEACHERS offer versatile indoor seating that can be tipped up and moved to other locations, making them perfect for facilities with limited space or multiple seating areas • Available up to 27' in length, with up to 4 rows of seating • Swivel casters make moving easy and rubber foot pads help protect flooring • Tip 'n rolls should not be tipped outdoors due to wind safety hazard.



TRB0315DF



GSNB1021WA



GSNB0321DF

STATIONARY BLEACHERS

GSNB SERIES STATIONARY BLEACHERS are available in lengths of 7' 6" up to 27', with up to 10 rows of seating capacity for most models • Low rise models ("LR" Series) have 3 or 4 rows and do not require guardrails or aisles to meet building codes • Stationary bleachers are available with aisles and handrail ("WA" Series) for increased comfort and convenience for spectators.

TRANSPORTABLE BLEACHERS

TRANSPORTABLE BLEACHERS provide a mobile option for facilities that need outdoor seating in multiple areas • All models are constructed with aluminum frames with galvanized steel lift angle for added strength while moving • All of our transportable models include chainlink guardrail as standard • Available in 15', 21', and 27' lengths, with 5 rows of seating • Not intended for over the road use; we recommend maximum 5 MPH towing speed • Add model GSNBTK transport kit when ordering.



GSNB0527DFTP

BENCHES

Heavy-duty ALUMINUM BENCHES offer affordable, low-maintenance seating for players, visitors, or spectators • Seats and backs are comprised of 10" wide anodized aluminum planks • Frames are constructed of heavy-gauge galvanized steel for maximum support and years of use • Available in 7' 6", 15', 21' and 27' lengths • All sizes and styles available in portable, inground, or surface mount installation • Portable models with backs are available with shelf attached to backrest (not pictured).

BENCHES WITH BACKS



PORTABLE

BENCHES WITHOUT BACKS



SURFACE MOUNT

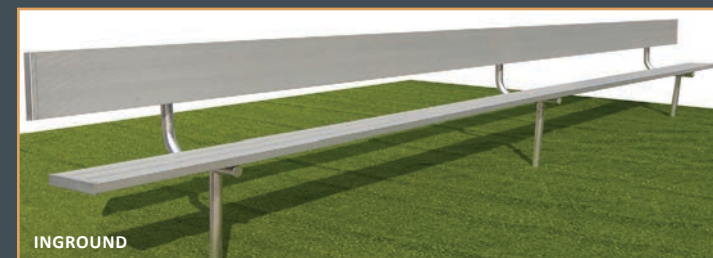

INGROUND



PORTABLE

FEATURED FACILITIES



FOLEY EVENT CENTER | FOLEY, ALABAMA
FOLEY EVENT CENTER | FOLEY, ALABAMA
HOOVER SPORTS COMPLEX | HOOVER, ALABAMA
HOOVER SPORTS COMPLEX | HOOVER, ALABAMA
DRIVE NATION SPORTS | DALLAS, TEXAS
DRIVE NATION SPORTS | DALLAS, TEXAS
WESTERN STATE UNIVERSITY | GUNNISON, COLORADO
WESTERN STATE UNIVERSITY | GUNNISON, COLORADO
BLUE VALLEY REC CENTER | OVERLAND PARK, KANSAS
BLUE VALLEY REC CENTER | OVERLAND PARK, KANSAS
TOWN AND COUNTRY SPORTS CLUB | WILDER, KENTUCKY
TOWN AND COUNTRY SPORTS CLUB | WILDER, KENTUCKY
ST. JOHNS PREP | DANVERS, MASSACHUSETTS
ST. JOHNS PREP | DANVERS, MASSACHUSETTS
SALEM UNIVERSITY | SALEM, MASSACHUSETTS
SALEM UNIVERSITY | SALEM, MASSACHUSETTS
ATLANTA HIGH SCHOOL | ATLANTA, GEORGIA
ATLANTA HIGH SCHOOL | ATLANTA, GEORGIA
SAGINAW VALLEY STATE | UNIVERSITY CENTER, MICHIGAN
SAGINAW VALLEY STATE | UNIVERSITY CENTER, MICHIGAN
CORNING-PAINTED POST HIGH SCHOOL | CORNING, NEW YORK
CORNING-PAINTED POST HIGH SCHOOL | CORNING, NEW YORK
DEKALB YMCA | AUBURN, INDIANA
DEKALB YMCA | AUBURN, INDIANA
ST. LAWRENCE COLLEGE | KINGSTON, ONTARIO, CANADA
ST. LAWRENCE COLLEGE | KINGSTON, ONTARIO, CANADA
ABILITIES CENTRE | WHITBY, ONTARIO, CANADA
ABILITIES CENTRE | WHITBY, ONTARIO, CANADA
ROBERT S. ALEXANDER HIGH SCHOOL | DOUGLASVILLE, GEORGIA
ROBERT S. ALEXANDER HIGH SCHOOL | DOUGLASVILLE, GEORGIA
BENTON RIVER CENTER | BENTON, ARKANSAS
BENTON RIVER CENTER | BENTON, ARKANSAS
CITY WAY YMCA | INDIANAPOLIS, INDIANA
CITY WAY YMCA | INDIANAPOLIS, INDIANA
TBK BANK SPORTS ARENA | BETTENDORF, IOWA
TBK BANK SPORTS ARENA | BETTENDORF, IOWA
BADGER FIELDHOUSE | CARMEL, INDIANA
BADGER FIELDHOUSE | CARMEL, INDIANA
WEST MONROE SPORTSPLEX | WEST MONROE, LOUISIANA
WEST MONROE SPORTSPLEX | WEST MONROE, LOUISIANA
HENRICO SPORTS & EVENTS CENTER | GLEN ALLEN, VIRGINIA
HENRICO SPORTS & EVENTS CENTER | GLEN ALLEN, VIRGINIA
MORRISTOWN LANDING | MORRISTOWN, TENNESSEE
MORRISTOWN LANDING | MORRISTOWN, TENNESSEE



**Kraftsman Commercial
Playgrounds & Water Parks**

19535 Haude Rd.
Spring, TX 77388

800.451.4869

info@kraftsmanplay.com

kraftsmanplay.com

